

DS08

Viscosity Compensated Variable Area Flow Meter and Switch Mounting Independent for High Pressure Applications

- for viscous media up to 600 cSt
- mounts in any position without recalibration
- compact design, high switching accuracy
- version in brass or stainless steel
- very small switching hysteresis
- robust design without glass measuring tube
- suitable for high operating pressures
-  Ex- version acc. to ATEX optional
- analogue transmitter 4...20 mA optional
- P_{\max} : 350 bar, T_{\max} : 160 °C

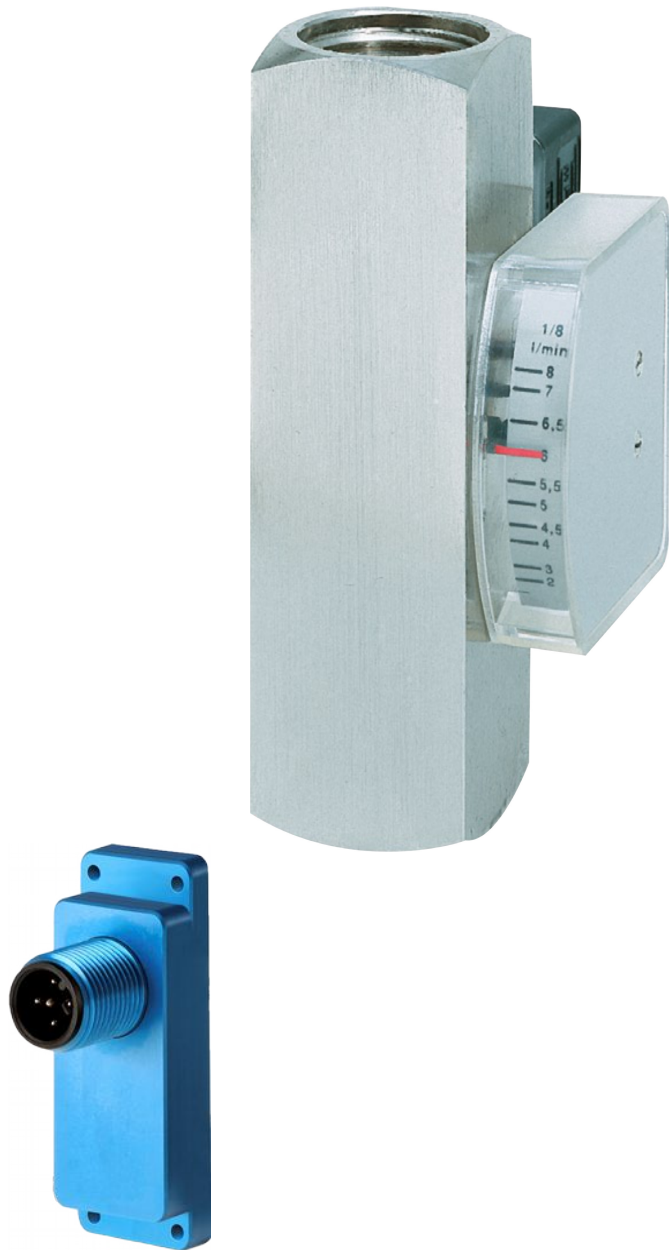

Description:

The flow meter and switch model DS08 works according to a modified variable area principle. The float is guided in a cylindrical measuring tube by means of a spring. The flowing medium moves the float in the flow direction.

An externally mounted pointer indicator is magnetically coupled to the float and thus, following the float position, indicates the flow rate on a scale. A Reed contact is mounted outside the meter in a sealed housing. When the float reaches the position of the Reed contact the switch will close. With higher flows the float moves further upward until it reaches a built-in float stop, still keeping the switch closed. This ensures a bistable switch function at any time.

Viscosity compensation, mounting position and reliability:

The built-in spring and the magnetic float guarantee an absolute reliability of the meter. This spring, which pushes the float back towards its zero position against the flow makes it possible to use the meter in any mounting position. The spring is artificially aged, thus eliminating the need for recalibration to the different mounting positions. The strong spring and an orifice in the float work together to limit the effects of viscosity changes to an absolute minimum compared to regular variable area flow meters.

Typical applications:

The variable area flow meter and switch model DS08 is used for measuring and monitoring the flow of viscous liquids, i. e. in central lubricating systems, any other lubricating circuitry, hydraulics, transformer oils etc.

Models:

Measuring range: 0,1–0,8 l/min ... 35–110 l/min
liquids with viscosity up to
600 cSt,
measuring range 01/03/06 up to 200 cSt

Materials: brass or stainless steel

Technical Data:

Max. pressure: brass version:
300 bar (DS08.M.)
250 bar (DS08.S.)
stainless steel version:
350 bar (DS08.M.)
300 bar (DS08.S.)

Pressure drop: 0,02 bar–0,2 bar (DS08.M)
0,02 bar – 0,4 bar (DS08.S.)

Viscosity range: 30 cSt to 600 cSt

**Max. media-
temperature:** 100 °C (optional 160 °C)
Ex-devices under. ATEX- identification

Operating temp.: 70 °C with analogue transmitter AZ06

Electr. connection: angle plug acc. to DIN 43650,
Ex-contact with 2 m cable
optional: 1 m cast cable
round plug M12 x 1 acc. to EN 50044,
angle plug with LED or glow lamp

Accuracy: ± 10 % of full scale

Materials:

Brass version:

Wetted parts:
measuring tube: brass (nickel plated outside)
spring: stainless steel 1.4571
seals*: FKM (optional NBR, EPDM)
magnet: hard ferrite

all other wetted parts: brass

Stainless steel version (1.4571):

Wetted parts:
seals*: FKM (optional NBR, EPDM)
magnet: hard ferrite

all other wetted parts: stainless steel 1.4571

*only with reduced connection

Order Code:

Order number: DS08. S. 4. 1. 1. 06. 1. 1. 1. 0

**Variable area flow meter
and switch**

Models:

M = miniature
S = standard

Connection:

1R = reduction to G ¼
only for measuring range 01-03
and 06-08
2R = reduction to G ½,
only for measuring range 06-12A
2 = female thread G 1/2
(Standard for DS08.M)
3R = reduction G ¾
only for measuring range 06-15A
4 = female thread G 1
(standard for DS08.S)

Materials:

1 = brass
2 = stainless steel 1.4571

Scale:

1 = for viscous medium

**Measuring ranges: Extended
measuring measuring
only DS08.M: ranges.:**

01 = 0,1–0,8 l/min (max. 200 cSt)
03 = 0,5–1,6 l/min (max. 200 cSt)
04 = 0,8–3 l/min
05 = 2–7 l/min

only DS08.S:
06 = 0,1–0,8 l/min (max. 200 cSt)
07 = 0,5–1,5 l/min
08 = 1–4 l/min
09 = 2–8 l/min
10 = 3–10 l/min
11 = 5–15 l/min
12 = 8–24 l/min 12A = 1–20 l/min
13 = 10–30 l/min 13A = 4–40 l/min
14 = 15–45 l/min 14A = 5–50 l/min
15 = 20–60 l/min 15A = 8–60 l/min
16 = 30–90 l/min 16A = 12–70 l/min
17 = 35–110 l/min 17A = 15–80 l/min

Flow indicator:

0 = switch only, without flow indicator
1 = flow meter and -switch, with flow indicator

Number of contacts:

0 = without contact (only for devices with display and/or AZ06)
1 = 1 contact
2 = 2 contacts

Contact function / analogue output:

(contact or analogue transmitter available)

0 = without
1 = N/O
2 = SPDT
2X = SPDT for SPS application
3ST5 = Ex-N/O, T5 (100 °C), with 2 m cable, for DS08.S
3ST6 = Ex-N/O, T6 (80 °C), with 2 m cable, for DS08.S
3UT5 = Ex-SPDT, T5 (100 °C), with 2 m cable, for DS08.S
3UT6 = Ex-SPDT, T6 (80 °C), with 2 m cable, for DS08.S
3SM = Ex-N/O for DS08.M
3UM = Ex-SPDT for DS08.M
SU20 = analogue transmitter 4...20 mA and 0...10 V

Options:

0 = without
1 = please specify in plain text
HT = high temperature version 160 °C
M12 = round plug M12x1 acc. to EN 50044 (Tmax. 85 °C)
Kx = cable version 1 m, 2 m, 5 m, or 10 m

Dimensions:

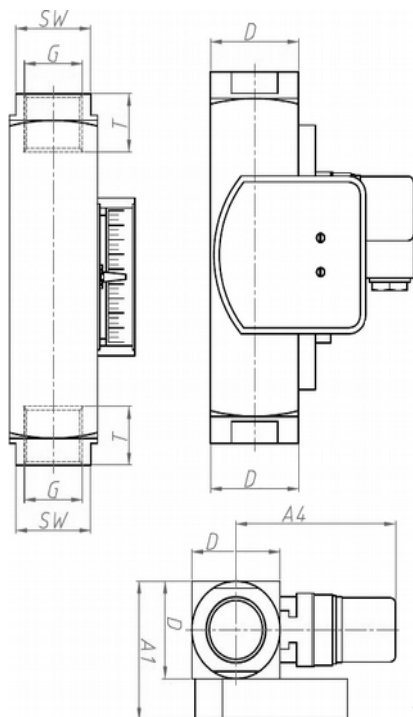

Dimensions:

Type	Installation dimensions [mm]							Weight [g] with/with- out display
	SW	D	A1	A4	G	T	L	
DS08.M	27	31	48	48	G 1/2	14	90	350/---
DS08.S	40	40	57	68	G 1	17	130	1000/1050
with reduction								
DS08.M					G 1/4	14	98	400/---
					G 3/8	14	108	450/---
DS08.S					G 1/4	21	152	1100/1150
					G 1/2	21	152	1100/1150
					G 3/4	21	152	1100/1150

Contacts:

The contact opens/changes, if the flow level has fallen under the adjusted value.

Type	Size	Contact function	Contact rating			
			Angle plug IP65	M12x1 plug IP67**	Cable connection (1 m) IP67	
DS08.M	1/2"	1 = N/O	230 V / 3 A / 60 VA	125 V / 3 A / 60 VA	230 V / 3 A / 60 VA	
		2 = SPDT	250 V / 1,5 A / 50 VA, min load: 3 VA	125 V / 1,5 A / 50 VA, min load: 3 VA	-/-	
		2X = SPDT for SPS	250 V / 1 A / 60 VA	-/-	-/-	
		3SM = Ex-N/O*	gas: < 30 V / 0,101 A / 0,76 W dust: < 30 V / 0,25 A / 0,75 W		gas: < 30 V / 0,101 A / 0,76 W dust: < 30 V / 0,25 A / 0,75 W	
		3UM = Ex-SPDT*			-/-	
DS08.S	1/4" 1/2" 3/4" 1"	1 = N/O	250 V / 3 A / 100 VA			
		2 = SPDT	250 V / 1,5 A / 50 VA, min load: 3 VA			
		2X = SPDT for SPS	250 V / 1 A / 60 VA	-/-	-/-	
		3ST5 = Ex-N/O, T5* 3ST6 = Ex-N/O, T6*	-/-	-/-	250 V / 2 A / 60 VA (2 m cable)	
		3UT5 = Ex-SPDT, T5* 3UT6 = Ex-SPDT, T6*	-/-	-/-	250 V / 1 A / 30 VA, min load: 3 VA (2 m cable)	

*Exact max. switching capacity: see ATEX documents

** Safety class M12x1 plug for DS08.M: IP65

ATEX-designations:

Contacts 3SM and 3UM for DS08.M:

ATEX II 2 G Ex ib IIC and ATEX II 2 D Ex ib IIIc
for connection to certified intrinsically safe circuit,
temperature range $-5\text{ °C} < T_{\text{service}} < 45\text{ °C}$, $L_i=0$, $C_i=0$

Contacts 3ST5, 3ST6, 3UT5, 3UT6 for DS08.S.:

ATEX II 2 G Ex mb IIC T6 Gb, ATEX II 2 D Ex tb IIIc T80 °C Db
ATEX II 2 G Ex mb IIC T5 Gb, ATEX II 2 D Ex tb IIIc T100 °C Db
(only with cable connection, standard 2 m)

Analogue Transmitter SU20:

The position of a magnetic float / piston is detected by means of Hall sensors and converted into an analogue signal. .

- analogue signal 4...20 mA and 0...10 V
- operating temperature: -20... +70 °C
- accuracy: +/- 10 % of full scale
- Aluminium housing, anodized



Technical Data:

Accuracy*:	+/- 1 % of full scale
Operating temperature:	-20...+70 °C
Storage temperature:	-20...+80 °C
Repeatability:	tbd.
Housing material:	Aluminium, blue anodized
Protection class:	IP67

* The actual accuracy depends on the flow sensor used. On request the accuracy of the flow sensor used can be significantly increased by a customized calibration.

Electrical Data:

Analogue output:	4...20 mA and 0...10 V
Power supply:	24 V _{CD} (19...30 V _{DC})
Power consumption:	< 1 W
Current output:	max. load 600 Ohm
Voltage output	max. current 10 mA
Connection:	round plug M12x1, 5-pole

Notes:

Flowmeter and analogue transmitter SU20 have been optimally adjusted to each other and may not be exchanged.

Electrical Connection:

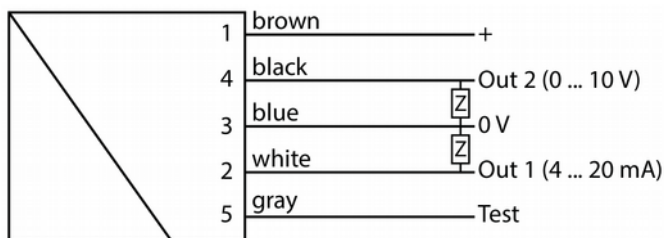

Attention: Pin 5 must not be electrically connected! We strongly recommend use of a four core cable.

Dimensions:

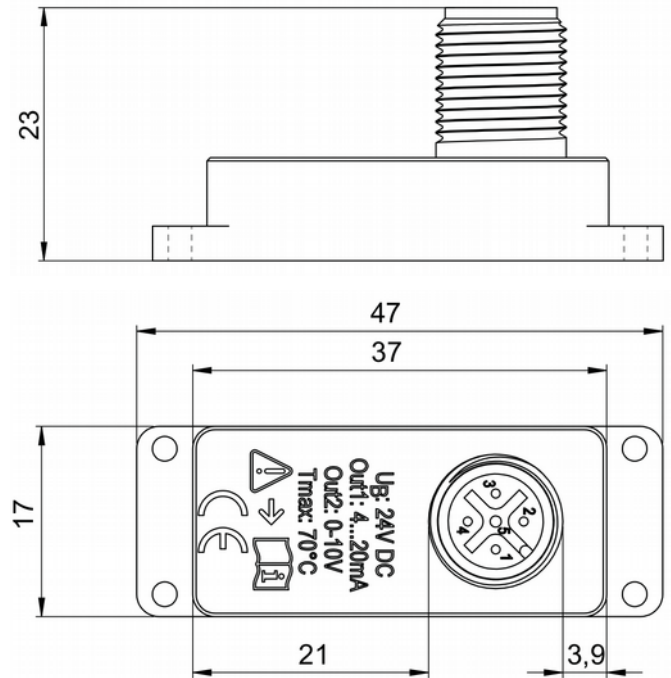

Characteristics:

Current-Flow characteristic:

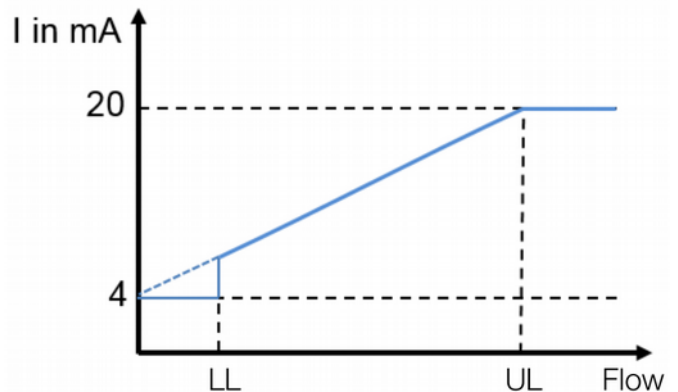

Voltage-Flow characteristic:

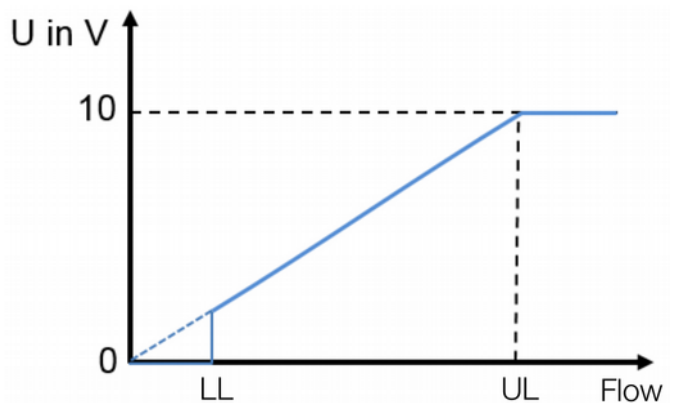

LL: lower limit of measuring range
UL: upper limit of measuring range

Accessories (see separate data sheets):

- Needle valves SNV01, SNV02



- Ball valves SKG01, SKG02



- Dirt traps SF00, SF01



- Protection relay MSR01



- M12 Plug connector PVC-cable SM12



Notes:

The specified measuring/switching ranges apply when the instrument is installed vertically and the flow rate is from bottom to top.

Other installation positions or operating densities deviating from the specified specifications increase the specified measuring error.

Special scales for different media and operating conditions are available on request.

The specified switching points are shut-off points at falling flow rates. Please note that the switch-on points are higher due to the hysteresis.

For applications where pressure surges are to be expected, please contact PKP!