



Instruction Manual

PUM50

Miniature pressure transmitter



PKP Prozessmesstechnik GmbH
Borsigstraße 24
D-65205 Wiesbaden-Nordenstadt
Tel.: ++49-(0)6122-7055-0
Fax: ++49-(0)6122-7055-50
Email: info@pkp.de

Contents

- 1 General description
- 2 Safety information
- 3 Functional description
- 4 Electrical connection
- 5 Specifications (see attached datasheet)
- 6 Maintenance

1 General description

Series PUM50 pressure transmitters are noted for their reliable function and easy operation. To obtain the greatest benefit from this device, please observe the following cautionary statement:

Persons who are responsible for setting up or operating this device must be sure to read and understand the operating instructions and the safety information pertaining to it.

2 Safety information

To ensure safe operation, the device must only be operated according to the information in the operating instructions. When the device is in use, the regulations and safety standards applicable to the specific application must also be observed. This statement also applies to the use of accessories.

2.2 Proper Usage

Series PUM50 pressure transmitters are designed to measure pressure in process by converting the measured value into a proportional electrical signal. Any application extending beyond this specific intended use does not constitute proper usage. Series PUM50 pressure transmitters must not be employed as the sole means of avoiding hazardous conditions in machinery and installations. The machinery and installations must be designed in such a manner that faulty conditions and malfunctions will not present hazardous situations for operating personnel.

2.3 Qualified Personnel

Series PUM50 pressure transmitters must only be used by qualified, knowledgeable personnel trained in correct use of these devices. Qualified personnel are those persons familiar with setting up and assembling these devices, placing them in service and operating them. In addition, such personnel must also be qualified to perform the work associated with the application for which the device is being used.

3 Functional description

Series PUM50 pressure transmitters are built of a housing with an integrated measuring system and a sensor system directly built on to the measuring system.

4 Electrical connection

The pin assignment of the optional electrical limit switches is shown on the housing or the label.

5 Maintenance

Series PUM50 pressure transmitters are maintenance free. In accordance with your Quality management system you may establish a periodical interval of recalibration, e.g. annually.

PUM 50 – Pressure sensor - electrical connections

Two-wire system

Connector according to DIN EN 175301-803 Form A with junction box

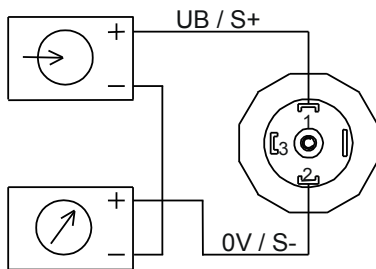

Connector according to DIN EN 175301-803 Form C with junction box

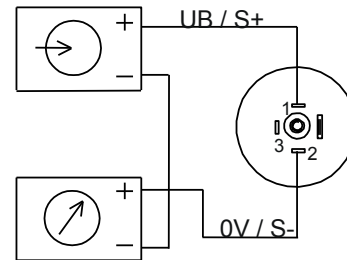

Circular plug-in connector M12x1

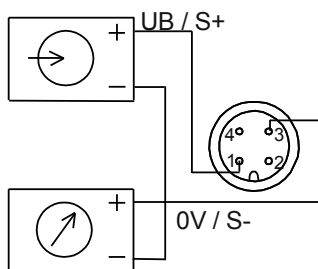

Cable outlet

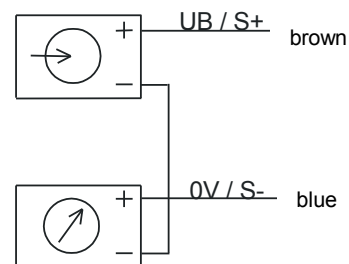

Three-wire system

Connector according to DIN EN 175301-803 Form A with junction box

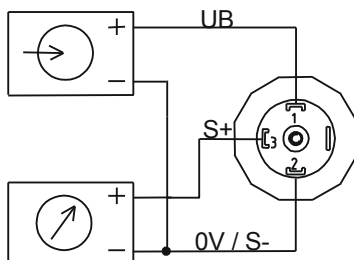

Connector according to DIN EN 175301-803 Form C with junction box

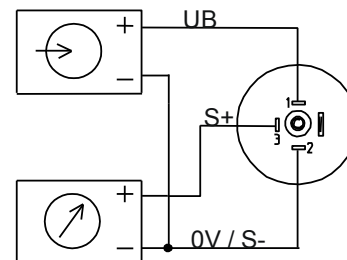

Circular plug-in connector M12x1

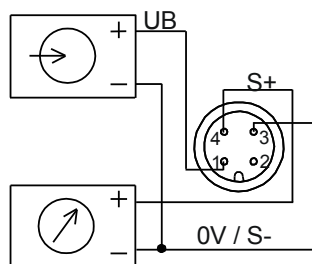

Cable outlet

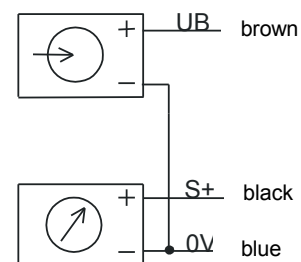

PUM50

OEM Miniature Pressure Transmitter

- accuracy: $\pm 1\%$ FS
- wetted parts made of stainless steel
- measuring ranges: -50...0 mbar to 0...1000 bar
- output signals: 4...20 mA or 0...10 V
- compact design
- max. temperature 100 °C



Description:

The PUM50 miniature pressure transmitter is suitable for use in most general industrial applications, providing long-term, reliable service life. Due to the well-proven technologies and materials used in their construction, these sensors are unaffected by caustic/corrosive vapors and liquids as well as mechanical stress and loads. The pressure port and the measuring cell are welded together, making gaskets or sealants between them unnecessary.

The compact design permits their use in confined spaces and in light-weight installations. Their technical specifications and economical price also make these sensors ideal for use in OEM applications.

Furthermore, these pressure sensors comply with the electromagnetic compatibility (EMC) requirements as per EN 61326.

Typical applications:

PUM50 pressure sensors are suitable for measuring and monitoring almost any liquids or gases.

Application can be found e.g. in the

- Pneumatics
- Hydraulics
- Pumps and compressors
- Building automation
- Test stands and benches
- General applications in industrial machinery and systems

Models:

Measuring ranges:	-50...0 mbar to 0...1000 bar
Output signals:	4...20 mA 0...10 V
Electr. connection:	angled plug acc. to DIN EN 175301-803 Form A round plug connector M12x1, 4-pin
Process connection:	
Standard:	G 1/4 A acc. to DIN EN ISO 1179-2
Optional:	G 1/2 A acc. to DIN EN ISO 1179-2 1/4" NPT male thread 1/2" NPT male thread

Technical Data:

Sensor element:		
-50...0 mbar to 0...6 bar:	piezo resistive	
0...10 to 0...1000 bar:	thin film	
Max. pressure:	2 x upper range end value	
Temperature range	Standard	Extended
Medium:	0...80 °C	-30...100 °C
Compensated:	0...80 °C	0... 80 °C
Ambient:	0...80 °C	-30...100 °C
Storage:	-20...80 °C	-30...100 °C
Materials:		
Wetted parts:	stainless steel 1.4534 and 1.4404	
Housing:	stainless steel 1.4404, PA	
Weight:	approx. 80 g	
Accuracy:	± 1 % FS	
Reproducibility:	± 0,1 % FS	
Long-term stability:	± 0,2 % FS (under reference conditions)	

Electrical Data:

Power supply:	8 ... 30 VDC (current output) 14 ... 30 VDC (voltage output)
Protection:	protected against reverse polarity, overvoltage and short circuits
with angled plug:	IP65
with round plug:	IP67
Response time:	≤ 4 ms (within 10% to 90% of the measuring range)

Dimensions:

G-thread (DIN 3852-E)

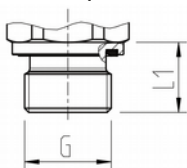

G	L1
G 1/4 A	14
G 1/2 A	17

NPT-thread

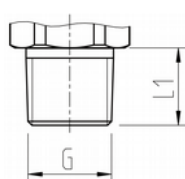

NPT	L1
1/4"	13
1/2"	19

Order Code:

Order number: PUM50. 1. 1. 08GA. R75. 0

**Miniature Pressure Transmitter
OEM design**

Output signals:

1 = 4...20 mA, 2-wire (standard)
2 = 0...10 V, 3-wire

Electrical connection:

1 = angled plug DIN EN 175301-803A
2 = round plug connector M12x1*

Process connection:

08GA = G 1/4 A acc. to DIN EN ISO 1179-2 (standard)
08N = 1/4" NPT male thread
15GA = G 1/2 A acc. to DIN EN ISO 1179-2
15N = 1/2" NPT male thread

Measuring ranges:

relative:

R02 = -50...0 mbar	R62 = 0...50 mbar
R04 = -25...+25 mbar	R63 = 0...100 mbar
R06 = -50...+50 mbar	R64 = 0...160 mbar
R08 = -50...+15 mbar	R65 = 0...250 mbar
R10 = -50...+20 mbar	R66 = 0... 400 mbar

absolute:

R69 = 0...1 bar	A69 = 0...1 bar
R70 = 0...1,6 bar	A70 = 0...1,6 bar
R72 = 0...2,5 bar	A72 = 0...2,5 bar
R73 = 0...4 bar	A73 = 0...4 bar
R74 = 0...6 bar	A74 = 0...6 bar
R75 = 0...10 bar	A75 = 0...10 bar
R76 = 0...16 bar	A76 = 0...16 bar

R77 = 0...25 bar
R78 = 0...40 bar
R79 = 0...60 bar
R80 = 0...100 bar
R81 = 0...160 bar
R82 = 0...250 bar
R83 = 0...400 bar
R84 = 0...600 bar
R85 = 0...1000 bar

Options:

0 = without
T = extended temperature up to 100 °C
9 = please specify in plain text

Accessory:

*) plug connector **SM12**, see
separate data sheet



Dimensions:

with round plug M12x1

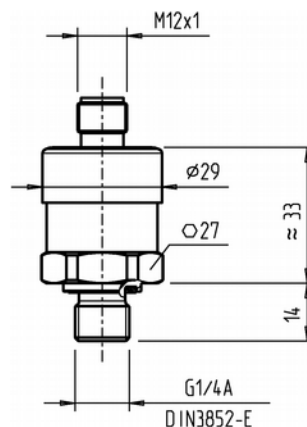

with angled plug Form A
≈ 48

