



Instruction Manual

DS05

***Variable Area Flowmeter and Switch
- with Glass Measuring Tube -***



PKP Prozessmesstechnik GmbH
Borsigstraße 24
D-65205 Wiesbaden-Nordenstadt
Tel.: ++49-(0)6122-7055-0
Fax: ++49-(0)6122-7055-50
Email: info@pkp.de

Table of Contents

Safety Information.....	2
Overview.....	3
Installation.....	4
Connecting devices equipped with Reed switches.....	6
Electrical connection.....	8
Setting the switch point.....	11
Electrical connection of analogue transmitter SU20.....	12
Troubleshooting guide.....	13
Maintenance / Maintenance plan.....	14
Degree of protection (IP-Code).....	14
Returns.....	14

Safety Information

General Instructions

To ensure safe operation, the device should only be operated according to the specifications in the instruction manual. The requisite Health & Safety regulations for a given application must also be observed. This statement also applies to the use of accessories. Every person who is commissioned with the initiation or operation of this device must have read and understood the operating instructions and in particular the safety instructions!

The liability of the manufacturer expires in the event of damage due to improper use, non-observance of this operating manual, use of insufficiently qualified personnel and unauthorized modification of the device.

Proper Usage

The variable area flowmeters of the DS05 series are used exclusively for monitoring and indicating continuous flows of liquid media that does not attack the materials used. All other usage is regarded as being improper and outside the scope of the device.

Process conditions:

Temperature range: -20...+100 °C (optional 160 °C),
max. pressure: 10 bar

In particular, applications in which shock loads occur (for example, pulsed operation) should be discussed and checked in advance with our technical staff.

In particular applications in which shock loads occur (e.g. intermittent operation) should be discussed and checked in advance with our technical staff.
Do not use flow monitors with fast-switching valves.

The series DS05 flow meter devices should not be deployed as the sole agents to prevent dangerous conditions occurring in plant or machinery. Machinery and plant need to be

designed in such a manner that faulty conditions and malfunctions do not arise that could pose a safety risk for operators.

Dangerous substances

For dangerous media such as e.g. Oxygen, Acetylene, flammable or toxic substances as well as refrigeration systems, compressors, etc. must comply with the relevant regulations beyond the general rules.

Qualified Personnel

The DS05 devices may only be installed by trained, qualified personnel who are able to mount the devices correctly. Qualified personnel are persons, who are familiar with assembling, installation, placing in service and operating these devices and who are suitably trained and qualified.

Inward Monitoring

Please check directly after delivery the device for any transport damages and deficiencies. Additional with reference to the accompanying delivery note the number of parts must be checked.

Claims for replacement or goods which relate to transport damage can only be considered valid if the delivery company is notified without delay.

Overview



- 1: Process connection (outlet)
- 2: Device body
- 3: Spring
- 4: Sight glass with measuring scale
- 5: Float containing magnets
- 6: Process connection (inlet)
- 7: Slot nozzle
- 8: Switch contact and female socket or switch contact with cable

Checking the flow:

In addition to the electrical control by the reed contact (switching contact), the actual flow rate can also be read off the measuring scale of the sight glass.

The top edge of the float is the read-off point. To obtain greatest reading accuracy, read-off at eye level. The read-off value can be falsified by viewing at an angle.

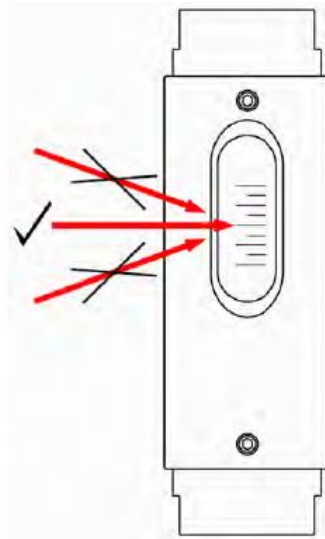

Installation

Process connection:

The following requirements must be observed to avoid damage to the flow monitor or the system:

- ◆ a process connection suitable for the device must be provided by the customer
- ◆ check connection size and screw-in depth
- ◆ use suitable sealants (liquid sealants damage the flow monitor if they run in)
- ◆ seal properly

Ambient conditions:

- ◆ do not install the flow monitor as a supporting part in a pipe system
- ◆ the medium must not carry solid bodies. Magnetic particles accumulate on the magnetic float and impair its function.
- ◆ Check corrosion and antifreeze agents from the application for compatibility.

Notice:

The following requirements must be observed, otherwise the function of the flow monitor is impaired or measurement results are falsified:

- ◆ external magnetic fields will influence the switch contact. Keep sufficient distance to magnetic fields (e.g. electric motors).
- ◆ piping, process connections or supports made of ferromagnetic material influence the magnetic field of the device. Keep a space of minimum 100 mm to those materials (e.g. steel).
- ◆ changes in cross-section, branch-offs or arcs in the pipe system impair measuring accuracy. Ensure that the unimpeded flow sections are maintained (in front of instrument 10 x nominal diameter, behind the instrument 5 x nominal diameter). Never reduce the pipe diameter immediately before the device.
- ◆ in the case of liquid media, take appropriate steps to ensure that the device is vented.
- ◆ to ensure measuring accuracy, the device must always be completely filled with medium.
- ◆ vent the pipeline. If there are air pockets in the line during the measurement, this could result in damage to the device caused by hydraulic shock. This may cause malfunctions.
- ◆ ensure that the plant is operating without cavitation. Cavitation may result in malfunctions and damage to the device.
- ◆ ensure that the medium is flowing continuously. Pulse-like staggered loads could destroy the device. This may result in serious injury to the user.
- ◆ if the medium is contaminated by solids, a strainer must be installed before the device (e.g. SF00 or SF01 from PKP)

Direction of flow:

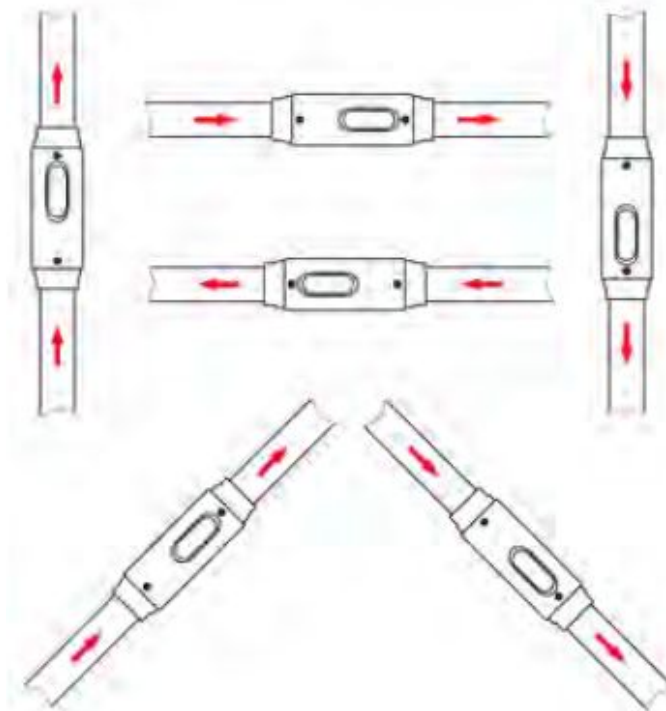

Only install the flow monitor in one of the positions displayed in the drawing. The medium must flow in the direction of the arrow (from a low to a high scale value).

Connecting devices equipped with Reed switches

Reed switches are basically designed for small contact ratings. To connect a load with higher power consumption it is indispensable to use a contact protection relay (e.g. our series MSR01)

If you connect directly a load to a Reed contact the following recommendations should be considered.

None of the contact rating values printed on the switching unit must not to be exceeded, even momentarily. This is valid for each of the given values individually: voltage, current, power. The Reed contact integrated in the switching unit is very sensible to electrical overload

Danger of overload is given by the following applications:

- inductive load
- capacitive load
- lamp load

Inductive Load

Inductive loads consist e.g. of relay, contactors, solenoid valves, motors, electric engines, etc.

⚠ WARNING: Voltage spikes at shut down (up to 10 times of nominal voltage)

Protective measures: (examples)

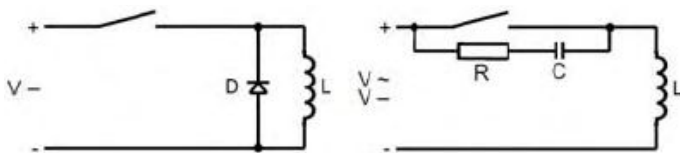

(Flyback diode, e.g. type 1N4007)

Capacitive Load

Capacitive loads consist e.g. of long connection cables or capacitive consumers.

⚠ WARNING: High current spikes at switching on (this will exceed the nominal current)

Protective measures: (examples)

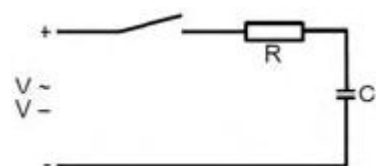

Limitation of current by a resistor

Lamp Load

Lamp loads consist e.g. by light bulbs, starting motors .

⚠ WARNING: High current spikes at switching on, because the glowing spiral has low resistance at low temperature.

Protective measures: (examples)

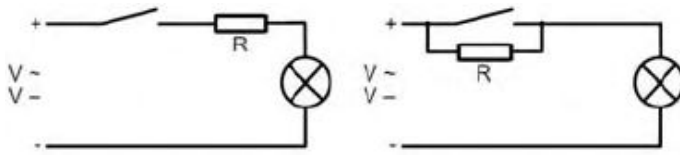

Limitation of current by a resistor or preheating of the glowing spiral.

Connecting to a PLC

There is no need for protective measures by connecting the Reed switch to a PLC. The Reed contacts are plated by Tunsten, Gold, and Rhodium located in a protective atmosphere. They can be directly connected to the input terminals of a PLC without problems.

RC-Circuits as protective measures (Boucherot cell, Snubber)

In practice the following values of resistor/capacitor cells give good results. Nevertheless, the values given in the following tables are only recommendations for general purposes. But it cannot be guaranteed that for specific applications more adequate Boucherot cells may exist.

For Reed switches of 10 – 40 VA

Voltage [V]	Resistance [Ohm]	Capacitance [nF]
230	1500	330
115	470	330
48	220	330
24	100	330

For Reed switches of 40 – 100 VA

Voltage [V]	Resistance [Ohm]	Capacitance [nF]
230	1000	330
115	470	330
48	100	330
24	47	330

Electrical connection

The switch contacts employed in these devices are potential free and do not require a power source.

Note:

Switch contacts and flow monitor have been optimally harmonized. After replacement of a switch contact, the switch point must be readjusted.

The contacts open/change when the flow rate falls below the set value.

Grounding of the device:



When installing the device in a pipeline, make sure that the device is grounded via the pipeline. This prevents dangerous potential differences from occurring

Switching capacity of contacts:



Type	Size	Contact function	Switching capacity		
			Angle plug IP65	M12x1 plug IP67	Cable connection (1 m) IP67
DS05.1	1/4"	1 = N/O	250 V / 3 A / 100 VA		
DS05.1A	3/8"	2 = SPDT	250 V / 1,5 A / 50 VA, min. Last: 3 VA		
DS05.2	1/2"				
DS05.3	3/4"	2X = SPDT for SPS	250 V / 1 A / 60 VA	-/-	-/-
DS05.4	1"	3ST5 = Ex-N/O, T5* 3ST6 = Ex-N/O, T6*	-/-	-/-	250 V / 2 A / 60 VA (2 m cable)
DS05.5	1 1/4"		3UT5 = Ex-SPDT, T5* 3UT6 = Ex-SPDT, T6*	-/-	-/-

* Exact max. switching capacity: see ATEX documents

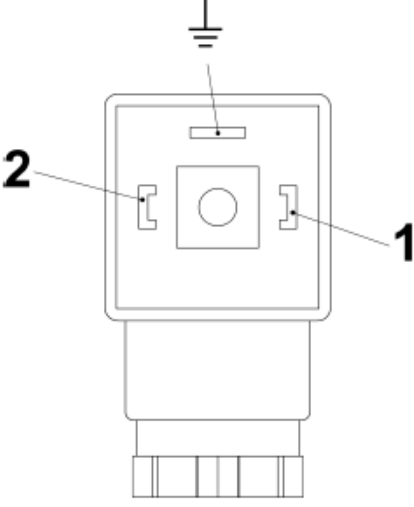
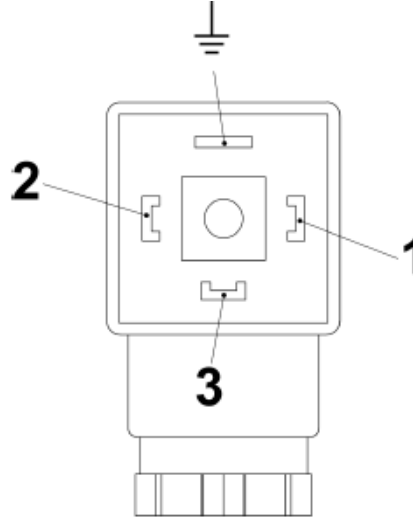
Switching contact with connector acc. to EN 175301-803:

Normally Open (NOC)	Change Over (COC)
	
Switch position under no-flow condition	Switch position under no-flow condition
	
The ground-pin is not used	The ground-pin is not used

Switching contacts with plug connector M12x1 (mating connector not included in delivery)

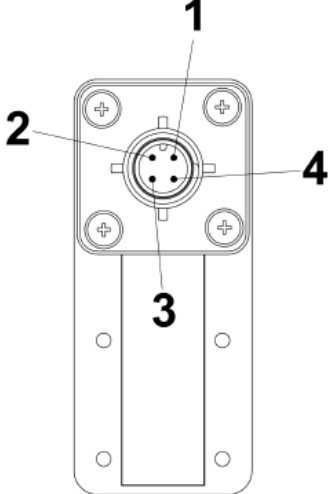
Normally Open (NOC)	Change Over (COC)
	
	
Switch position under no-flow condition	Switch position under no-flow condition

Switching contact with cable:

The individual cores of the cable are numbered according to the following connection diagram:

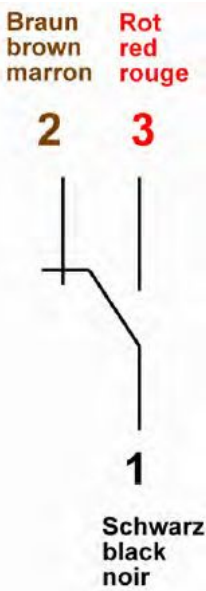
Normally Open (NOC)	Change Over (COC)
	
Switch position under no-flow condition	Switch position under no-flow condition

Setting the switch point

Setting the switch point of an installed device:

The following instructions describe the procedure for a Normally Open Contact (NOC). The actual state (open or closed), can be determined using a continuity meter.

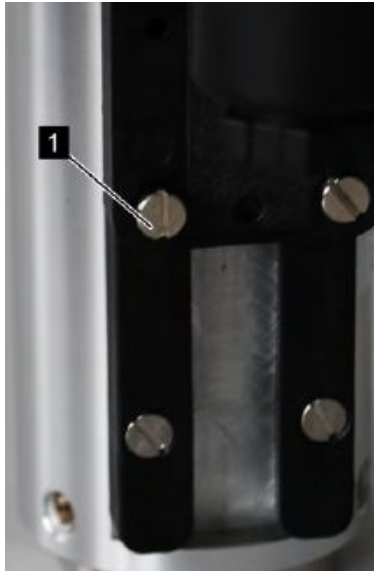

1. Adjust the flow to be monitored and read it off at the scale on the device. The top edge of the float is the read-off point.
2. Loosen the set screw of the switch contact (1)
3. Slowly push the switch contact in the opposite direction of flow up to the stop.
4. **Condition 1: The contact is closed:**
Slowly push the switch contact in the direction of flow until the contact opens.
5. **Condition 2: The contact is open:**
Slowly push the switch contact in the direction of flow until the contact closes. Keep pushing slowly in the direction of flow until the contact opens.
6. Re-tighten the switch contact set screw using a hex screwdriver. Observe the correct tightening torque of 0,4 Nm.

The set switch point corresponds to the switch-off point of the switch contact by decreasing flow.

Setting the switch point of a non-installed device:

1. Loosen the set screws of the switch contact using a flat-bladed screwdriver
2. Using a non-magnetic rod (e.g. test rod), move the float to the point on the measuring scale that corresponds to the flow rate to be monitored. The top edge of the float is the read-off point
3. Slowly push the switch contact in the opposite direction of flow up to the stop
4. **Condition 1: The contact is now closed**
Slowly push the switch contact in the direction of flow until the contact opens
5. **Condition 2: The contact is now open**
Slowly push the switch contact in the direction of flow until the contact closes, then keep pushing slowly in the direction of flow until the contact opens
6. Tighten the set screws of the switch contact using a flat-bladed screwdriver. When doing so, observe the correct tightening torque (0,4 Nm) of the screws.

The set switch point corresponds to the switch-off point of the switch contact by decreasing flow.

Electrical connection of analogue transmitter SU20

Attention:

We recommend using only shielded connection cables.
The units are equipped with an integrated electronic unit and are ready for operation immediately after installation and connection.
Pin 5 must not be contacted electrically! Ideally, use a 4-pole cable.
Before connecting the unit electrically, make sure that the supply voltage matches the required one: 24 V_{DC} (19...30 V_{DC}).
Before connecting the unit electrically, the supply voltage must be switched off.
The analogue output is factory-set to the specified measuring range.



Connection:

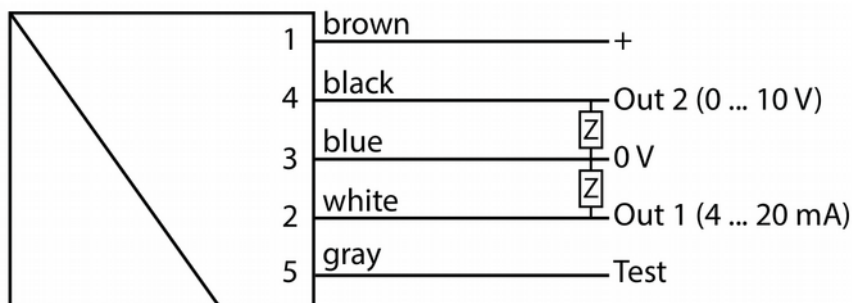

Characteristics:

Current-Flow characteristic:

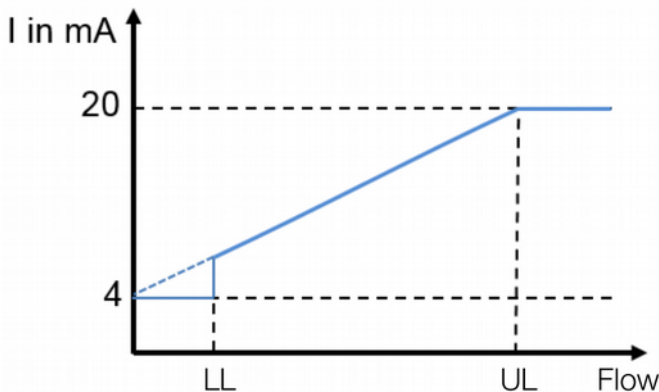

Voltage-Flow characteristic:

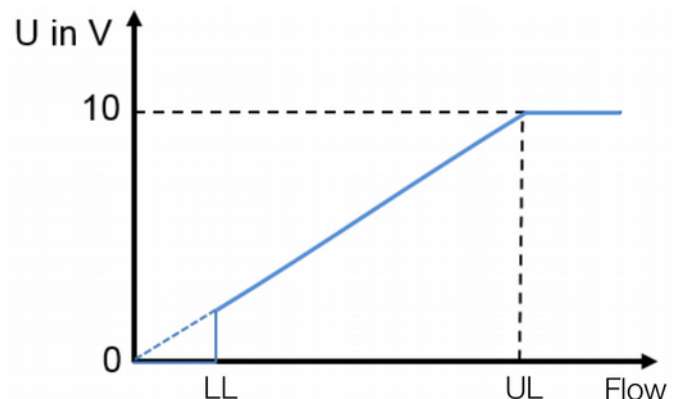

LL: lower limit of measuring range
UL: upper limit of measuring range

Operating conditions:

Operating temperature: -20...+70 °C
Storage temperature: -20...+80 °C
Accuracy*: ± 1 % of full scale
*The actual accuracy depends on the flow sensor used

Troubleshooting guide

Fault description	Cause	Remedy
The switch contact does not switch	No medium flowing through flow monitor	Check that medium is flowing through the pipeline
	Flow is too low or the switch contact is set too high	Adjust the switch contact to a lower flow rate
		Use the device at another measuring range
		Increase the flow rate
	Incorrect reduction fitting or pipe diameter is too small	Correct pipe diameter
	Float is stuck	Disassemble and clean the device
Switch contact is defective	Remedy the cause of the defect (short-circuit, overload)	
	Replace the switch contact	
Switch contact is permanently switched	Flow is too high or the switch contact is set too low	Reduce the flow
		Adjust the switch contact to a higher flow rate
		Use the device at another measuring range
Switch contact is permanently switched	Float is stuck	Disassemble and clean the device
	Switch contact is defective	Remedy the cause of the defect (short-circuit, overload)
		Replace the switch contact
The switch point is not the same as the actual flow rate	Improper scale installed for media used	Request proper conversion table or scale for media used
	Incorrect reduction fitting or pipe diameter is too small	Correct pipe diameter
	Device is dirty	Disassemble and clean the device
	Device is defective	Remove device from system and contact PKP

Maintenance / Maintenance plan

Intervals for replacing wear parts

DS05 type flow monitors require very little maintenance due to the small number of moving parts. The intervals for the replacement of wear parts depend significantly on the operating conditions as well as on the composition of the medium flowing through the device. For this reason, no intervals have been set by the manufacturer. The operator must determine suitable intervals based on the local conditions and circumstances.

Maintenance work:

- ◆ Visual inspection for dirt/soiling
- ◆ Visual inspection for free movement of float
- ◆ Visual inspection for leaks from the device
- ◆ Check function of switch contact

For detailed information on maintenance and cleaning of the device, please refer to a separate manual. Please ask for them if required.

Degree of protection (IP-Code)

Process connection	Specification of connection material	Degree of protection
EN 175301-803 with gland	Ø of connection cable: 6-8 mm	IP65
M12x1	Plug connector M12x1	IP67
Cable	--	IP67

Returns

For returns please contact us:

PKP Prozessmesstechnik GmbH
Info@pkp.de
+49 (0) 6122-7055-0

DS05

Variable Area Flowmeter and Switch, mounting independent

- for low viscosity liquids
- any mounting position without recalibration
- small mounting dimensions
- brass (nickel plated) or stainless steel version
- high switching accuracy
- scales burned into the sight glass
-  optional Ex- version acc. to ATEX
- analogue transmitter 4...20 mA optional
- P_{max} : 10 bar, T_{max} : 160 °C



Description:

The flowmeter and switch model DS05 works according to a modified variable area principle.

The float is guided in a cylindrical measuring glass by means of a spring. The flowing medium moves the float in the flow direction. The upper edge of the float shows the momentary flow via a burnt-in scale on the measuring glass.

A Reed contact is mounted outside the meter in a sealed housing. When the float reaches the position of the Reed contact the switch will close. With higher flows the float moves further upward until it reaches a built-in float stop, still keeping the switch closed. This ensures a bistable switch function at any time.

The Reed contact is adjustable over the full switching range of the meter.

Typical application:

The variable area flowmeters and monitors DS03 are used to measure and monitor continuous flow rates of low-viscosity liquids or gaseous media.

Areas of applications are:

- cooling systems
- engineering
- medical technology
- pharmaceutical and chemical industries
- research and development

Models:

Measuring ranges: 0,2–4 l/min ... 35–250 l/min water

Materials: brass (nickel plated) and stainless steel

Technical Data:

Max. pressure: 10 bar

Pressure loss: 0,02–0,8 bar

Max. media-temperature: 100 °C (optional 160 °C)
Ex-devices acc. to. ATEX-marking

Electr. Connection: angle plug acc. to EN 155301-803, form A (DIN 43650),
Ex-contact with 2 m cable
optional: cable connection
round plug M12 x 1 acc. to EN 50044
angle plug with LED or glow lamp

Accuracy: ± 5 % of full scale
(for vertical mounting)

Materials:

**Protective housing:
(non-wetted parts)** aluminium anodized

Brass version (nickel-plated):

Wetted parts:
float: stainless steel 1,4571
spring: stainless steel 1.4571
sight glass: borosilicate glass
gaskets: NBR, optional FKM, EPDM

all other wetted parts: brass, nickel plated

Stainless steel version (1.4571):

Wetted parts:
sight glass: borosilicate glass
gaskets: FKM, optional NBR, EPDM

all other wetted parts: stainless steel 1.4571

Order Code:

Order number: DS05. 3. 1. 1. 06. 1. 1. 0

**Variable area flowmeter-
and switch**

Connection female thread:

1 = G 1/4	1N = 1/4" NPT
1A = G 3/8	1AN = 3/8" NPT
2 = G 1/2	2N = 1/2" NPT
3 = G 3/4	3N = 3/4" NPT
4 = G 1	4N = 1" NPT
5 = G 1 1/4	5N = 1 1/4" NPT

Material:

1 = brass nickel-plated
2 = stainless steel 1.4571

Scale:

1 = for water

Measuring ranges:

DS05.1, DS05.1A and DS05.2:

01 = 0,2–4 l/min (water)
02 = 0,5–6 l/min (water)
03 = 0,5–8 l/min (water)
04 = 0,5–14 l/min (water)

only DS05.2:

05A = 2–22 l/min (water)
05 = 1–28 l/min (water)

only DS05.3:

06 = 1–45 l/min (water)

DS05.3 and DS05.4:

07 = 2–80 l/min (water)
07A = 6–90 l/min (water)

only DS05.4:

08 = 6–110 l/min (water)

only DS05.5:

09 = 15–150 l/min (water)
10 = 50–220 l/min (water)
11 = 50–250 l/min (water)

Number of contacts:

0 = without contact
1 = 1 contact
2 = 2 contacts

Contact function / analogue output:

0 = without
1 = N/O
2 = SPDT
2X = SPDT for SPS application
3ST5 = Ex-N/O, T5 (100 °C), with 2 m cable
3ST6 = Ex-N/O, T6 (80 °C), with 2 m cable
3UT5 = Ex-SPDT, T5 (100 °C), with 2 m cable
3UT6 = Ex-SPDT, T6 (80 °C), with 2 m cable
SU20 = analogue transmitter 4...20 mA and 0...10 V

Options:

0 = without
1 = please specify in plain text
HT = high temperature version 160 °C
M12 = round plug M12 x 1 acc. to EN 50044 (Tmax. 85 °C)
Kx = cable version 1 m, 2 m, 5 m or 10 m

Dimensions:

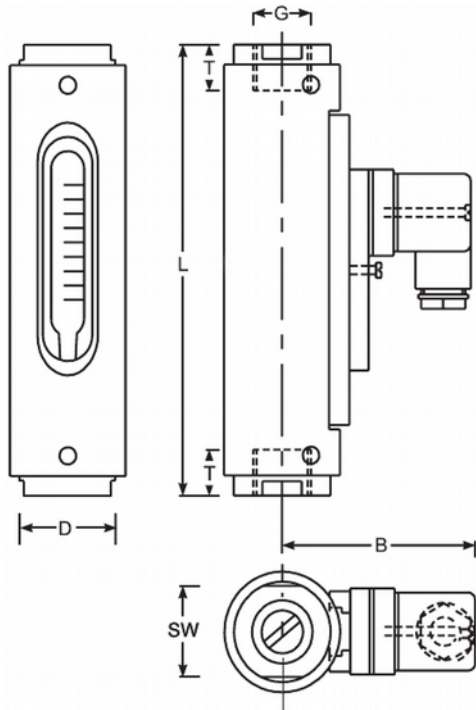

Dimensions:

Type	Dimensions [mm]						Weight appr.[g]
	SW	D	B	G	T	L	
DS05.1.x.x.x	32	43	73	G 1/4	10	132	625
DS05.1A.x.x.x	32	43	73	G 3/8	11	135	625
DS05.2.x.x.x	32	43	73	G 1/2	14	135	625
DS05.2.x.x.05	32	43	73	G 1/2	14	135	650
DS05.3.x.x.06	32	43	73	G 3/4	15	167	850
DS05.3.x.x.07	41	50	76	G 3/4	15	164	1000
DS05.4.x.x.07	41	50	76	G 1	17	184	1000
DS05.4.x.x.08	41	50	76	G 1	17	184	1000
DS05.5.x.x.09	50	55	79	G 1 1/4	20	216	1000
DS05.5.x.x.10	55	60	81	G 1 1/4	20	210	1700
DS05.5.x.x.11	50	55	79	G 1 1/4	20	222	1400

Contacts:

The contact opens/changes, if the flow level has fallen under the adjusted value

Type	Size	Contact function	Switching capacity		
			Angle plug IP65	M12x1 plug IP67	Cable connection (1 m) IP67
DS05.1	1/4"	1 = N/O	250 V / 3 A / 100 VA		
DS05.1A	3/8"	2 = SPDT	250 V / 1,5 A / 50 VA, min. Last: 3 VA		
DS05.2	1/2"				
DS05.3	3/4"	2X = SPDT for SPS	250 V / 1 A / 60 VA	-/-	-/-
DS05.4	1"	3ST5 = Ex-N/O, T5*	-/-	-/-	250 V / 2 A / 60 VA (2 m cable)
DS05.5	1 1/4"	3ST6 = Ex-N/O, T6*	-/-	-/-	250 V / 1 A / 30 VA, min load: 3 VA (2 m cable)
		3UT5 = Ex-SPDT, T5*	-/-	-/-	
		3UT6 = Ex-SPDT, T6*	-/-	-/-	

* Exact max. switching capacity: see ATEX documents

ATEX-designations:

Contacts 3ST5, 3ST6, 3UT5, 3UT6:

ATEX II 2 G Ex mb IIC T6 Gb, ATEX II 2 D Ex tb IIIC T80 °C Db
ATEX II 2 G Ex mb IIC T5 Gb, ATEX II 2 D Ex tb IIIC T100 °C Db
(with cable connection, Standard 2 m only)

Analogue Transmitter SU20:

The position of a magnetic float / piston is detected by means of Hall sensors and converted into an analogue signal. .

- analogue signal 4...20 mA and 0...10 V
- operating temperature: -20... +70 °C
- accuracy: +/- 10 % of full scale
- Aluminium housing, anodized



Technical Data:

Accuracy*:	+/- 1 % of full scale
Operating temperature:	-20...+70 °C
Storage temperature:	-20...+80 °C
Repeatability:	tbd.
Housing material:	Aluminium, blue anodized
Protection class:	IP67

* The actual accuracy depends on the flow sensor used. On request the accuracy of the flow sensor used can be significantly increased by a customized calibration.

Electrical Data:

Analogue output:	4...20 mA and 0...10 V
Power supply:	24 V _{CD} (19...30 V _{DC})
Power consumption:	< 1 W
Current output:	max. load 600 Ohm
Voltage output	max. current 10 mA
Connection:	round plug M12x1, 5-pole

Notes:

Flowmeter and analogue transmitter SU20 have been optimally adjusted to each other and may not be exchanged.

Electrical Connection:

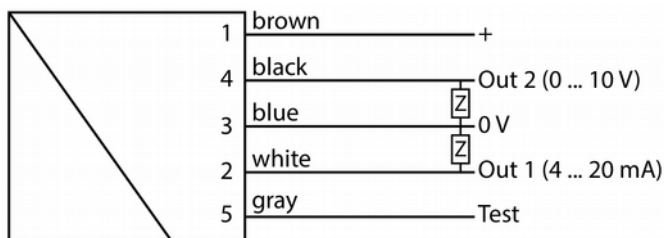

Attention: Pin 5 must not be electrically connected! We strongly recommend use of a four core cable.

Dimensions:

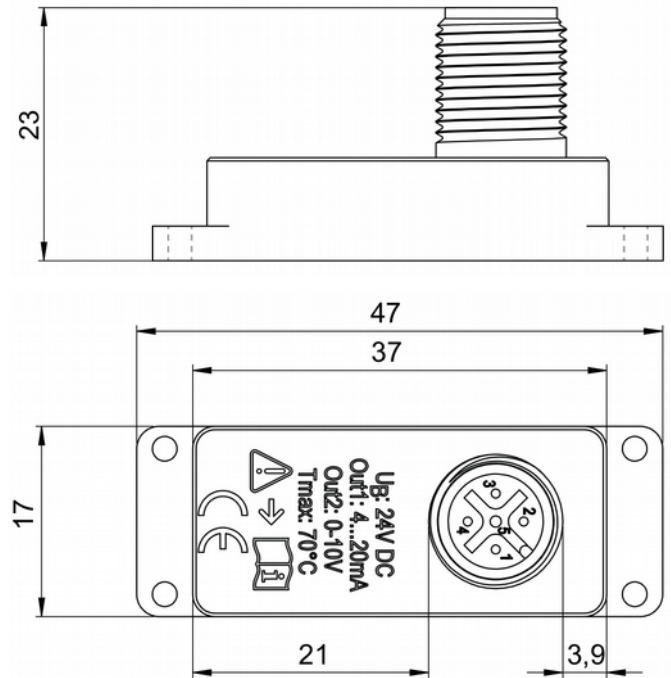

Characteristics:

Current-Flow characteristic:

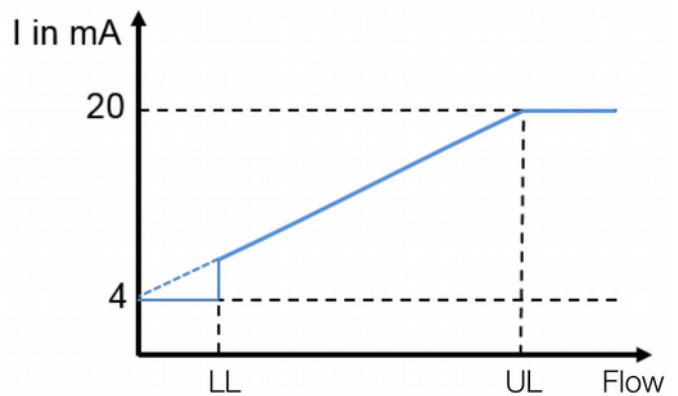

Voltage-Flow characteristic:

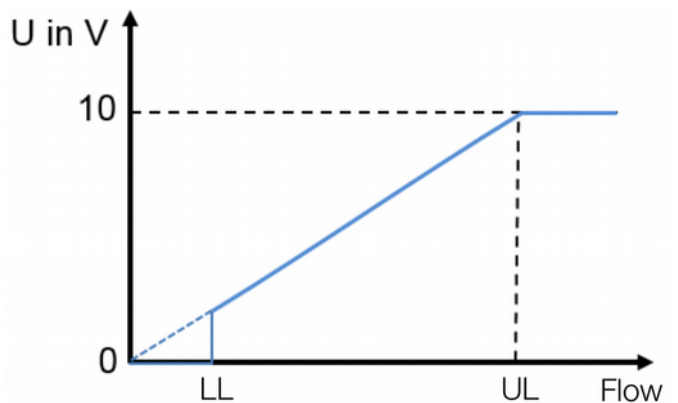

LL: lower limit of measuring range
UL: upper limit of measuring range

Accessories (see separate data sheets):

- Needle valves SNV01, SNV02



- Ball valves SKG01, SKG02



- Dirt traps SF00, SF01



- Protection relay MSR01



- M12 Plug connector PVC-cable SM12



Notes:

The specified measuring/switching ranges apply when the instrument is installed vertically and the flow rate is from bottom to top.

Other installation positions or operating densities deviating from the specified specifications increase the specified measuring error.

Special scales for different media and operating conditions are available on request.

The specified switching points are shut-off points at falling flow rates. Please note that the switch-on points are higher due to the hysteresis.

For applications where pressure surges are to be expected, please contact PKP!